

META META SLIM Single-lever basin mixer with pop-up waste - Champagne (22kt Gold)

















META

33 501 662



- 125mm projection
- fixed spout
- circular, air-enriched flow
- height of mixer 134 mm
- height up to aerator 52 mm
- hole diameter 35 mm
- 2x screw-in M 8 x 1 pressure hose, leak-tested
- max. flow 5.7 l/min
- lead-free
- This product can help a building meet the requirements of Green Building Rating Systems, e.g. LEED®, BREEAM®, DGNB

Only suitable for basins with an overflow.

	Champagne (22kt Gold)	33 501 662-47
	Chrome	33 501 662-00
	Brushed Platinum	33 501 662-06
	Platinum	33 501 662-08
	Dark Chrome	33 501 662-19
	Light Gold	33 501 662-26
	Brushed Light Gold	33 501 662-27
	Brushed Durabronze (23kt Gold)	33 501 662-28
	Red	33 501 662-29
	Orange	33 501 662-30
	Dark Green	33 501 662-31
	Matte Black	33 501 662-33
	Brushed Bronze	33 501 662-42
	Brushed Champagne (22kt Gold)	33 501 662-46
	Brushed Chrome	33 501 662-93
	Brushed Dark Platinum	33 501 662-99

33 501 662
mm [inches]

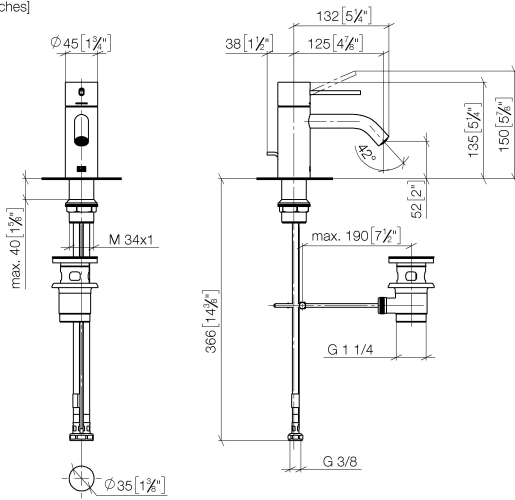

Flow rate chart



META META SLIM Single-lever basin mixer with pop-up waste - Champagne
(22kt Gold)

META

33 501 662

Parts for other
finishes can be found
here: [Chrome](#)

